

1109

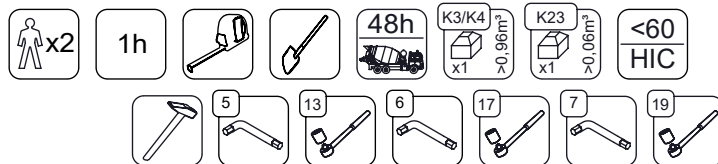

v011
12.06.2021
A. H.
[cm]

vinci
play

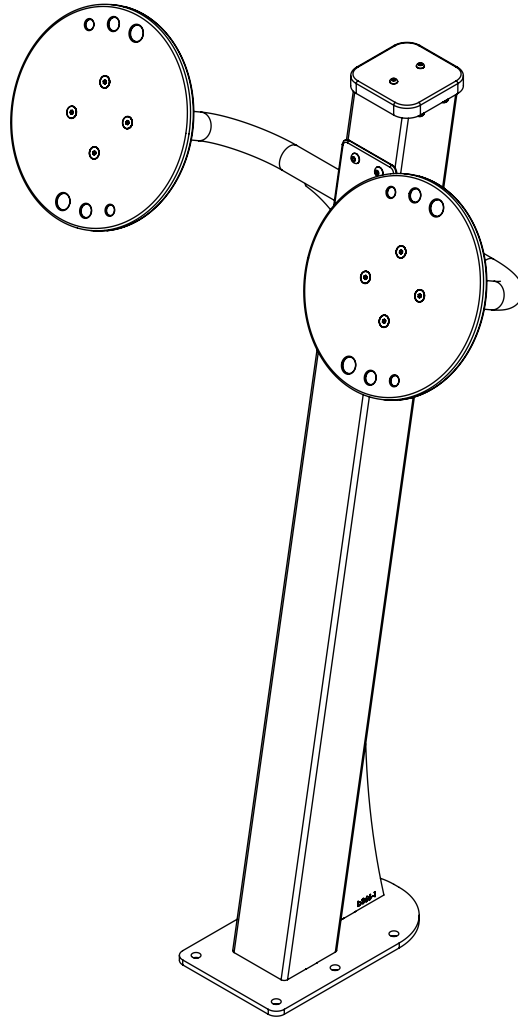
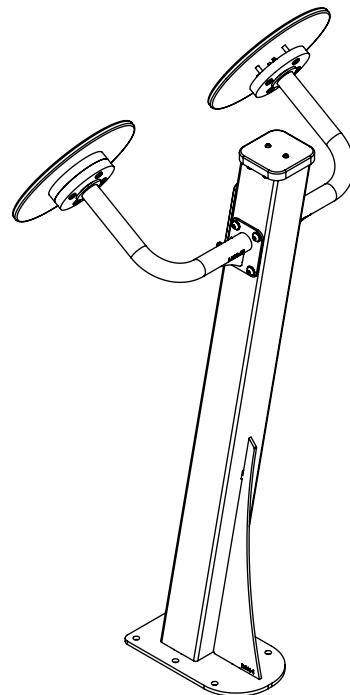
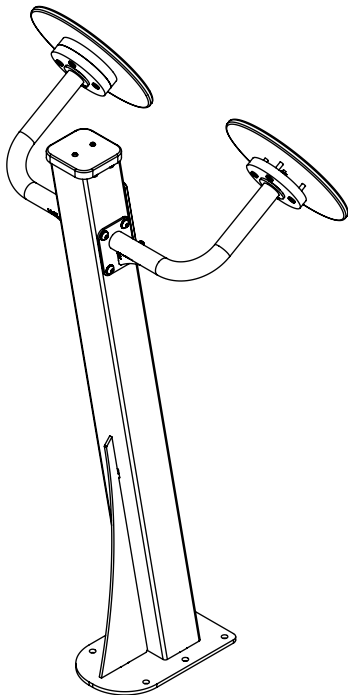
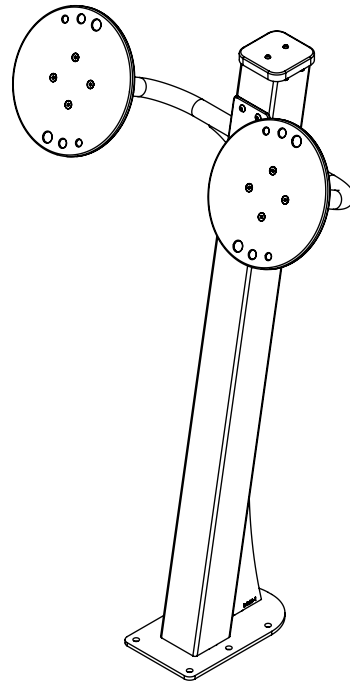
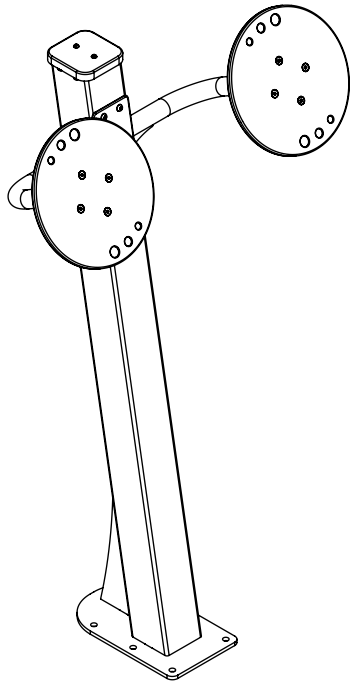

[cm]

vinci
play

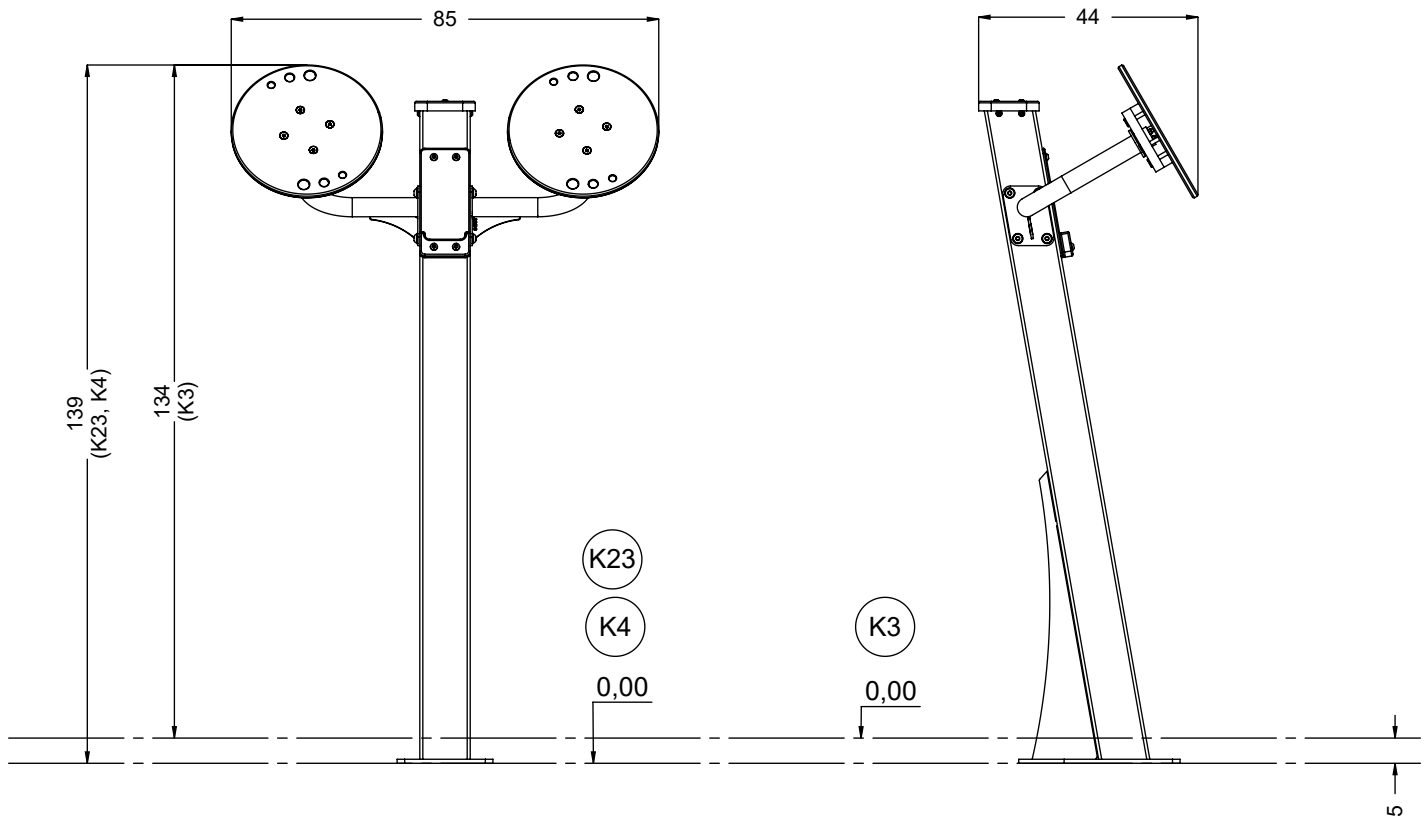

[cm]



vinci
play

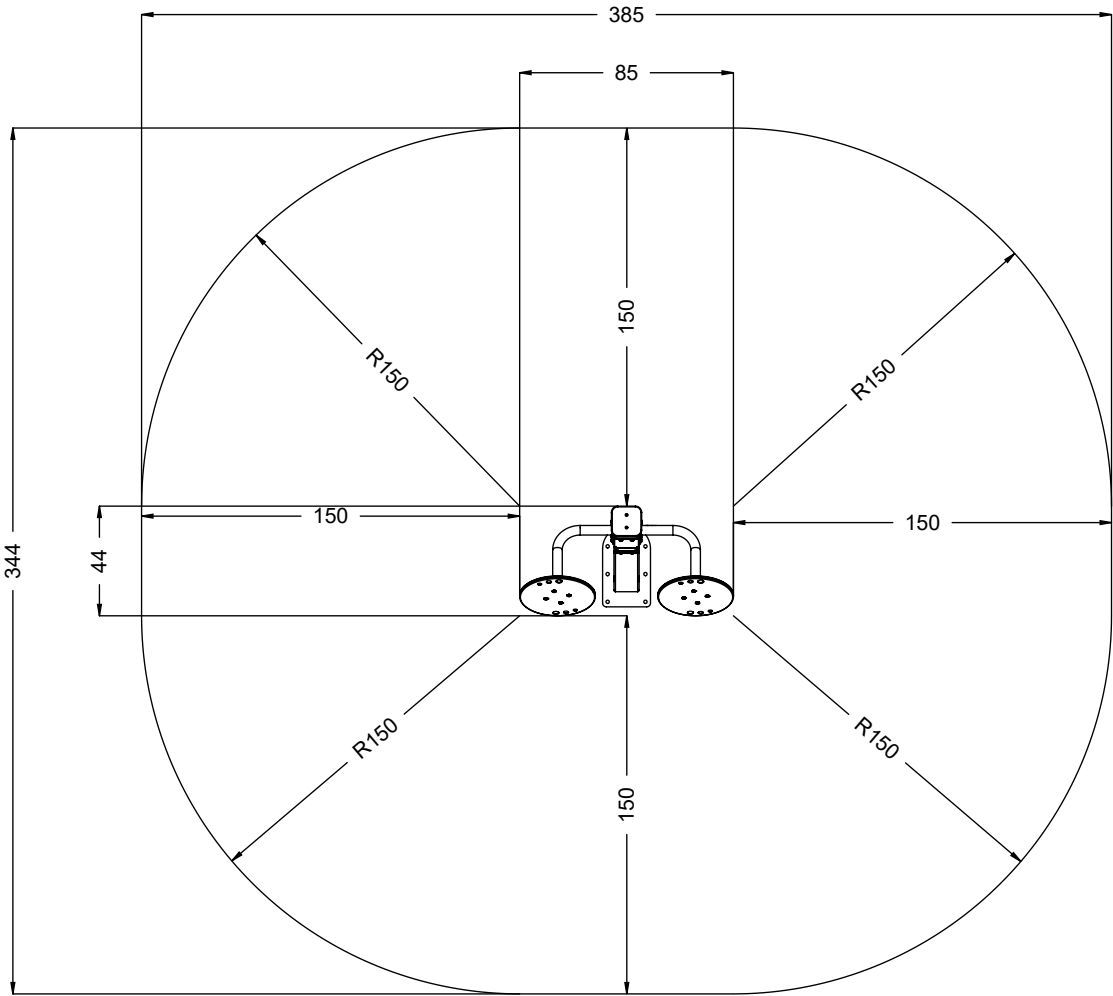

[cm]



vinci
play

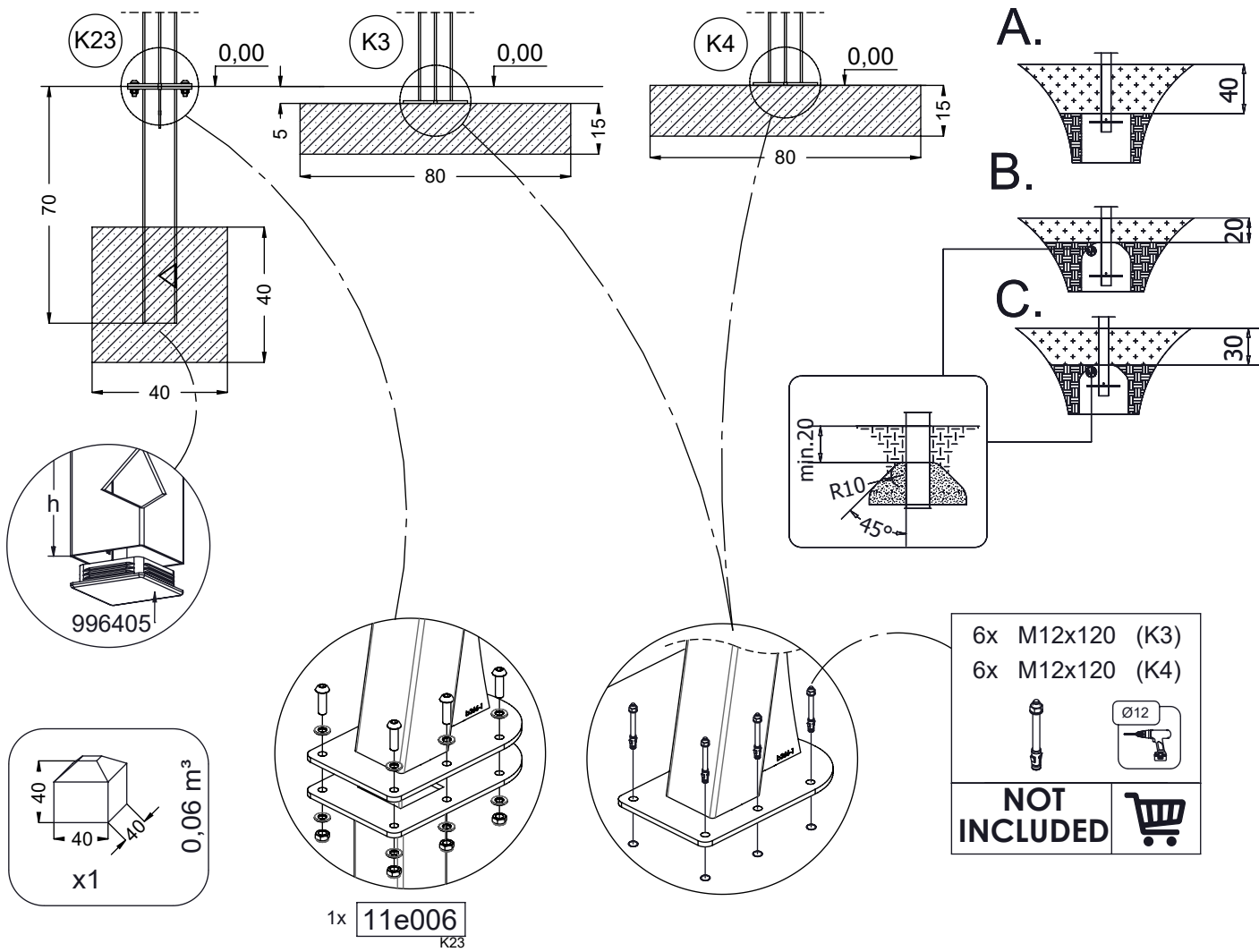

K23

K3 K4

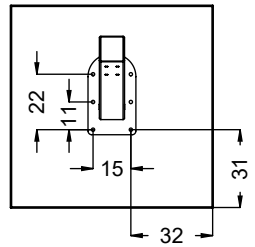
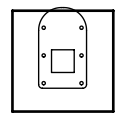

[cm]

x2
 1h

 48h
 K3/K4 x1 >0,96m³
 K23 x1 >0,06m³

vinci play

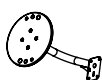

114134
114133 (inox)
x1



114036
114135 (inox)
x1

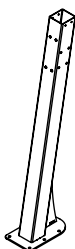

112250
112251 (inox)
x1

K23

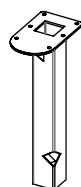

112111
x1

| ST/INOX | |
|---------|--------------|
| 1x | 11e006 (K23) |
| 1x | 11e001 |
| 1x | 11e002 |
| 2x | 11e004 |
| 1x | 116109 |
| 2x | 11e020 |
| 1x | 996405 |

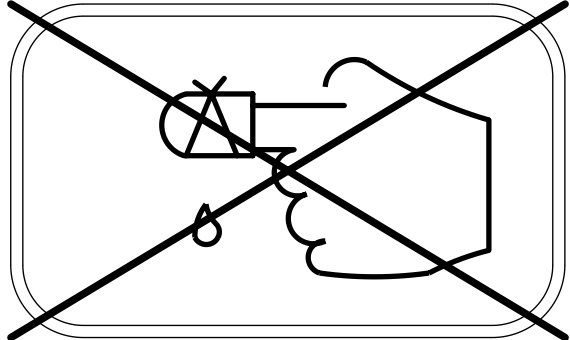
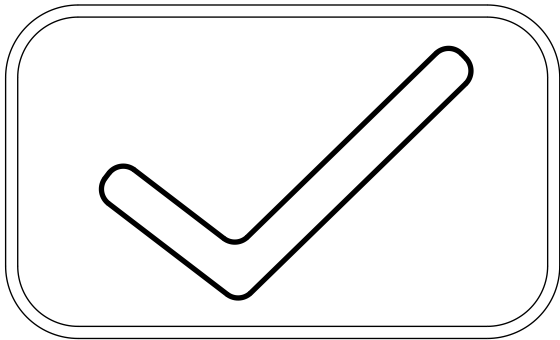
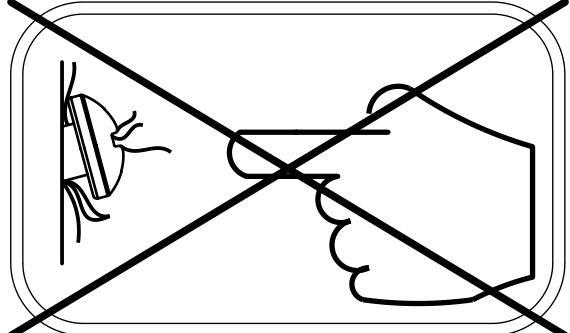
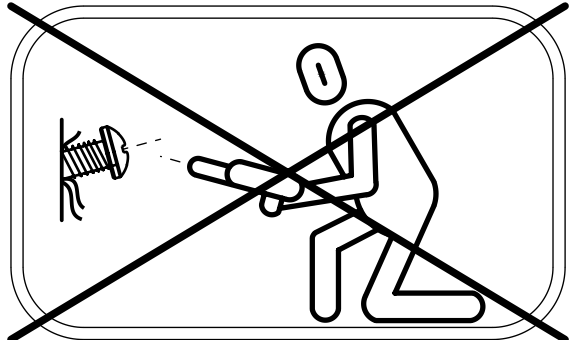
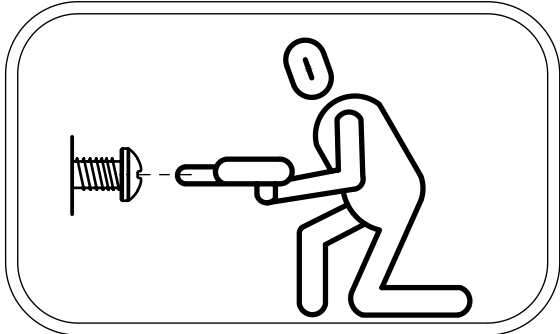

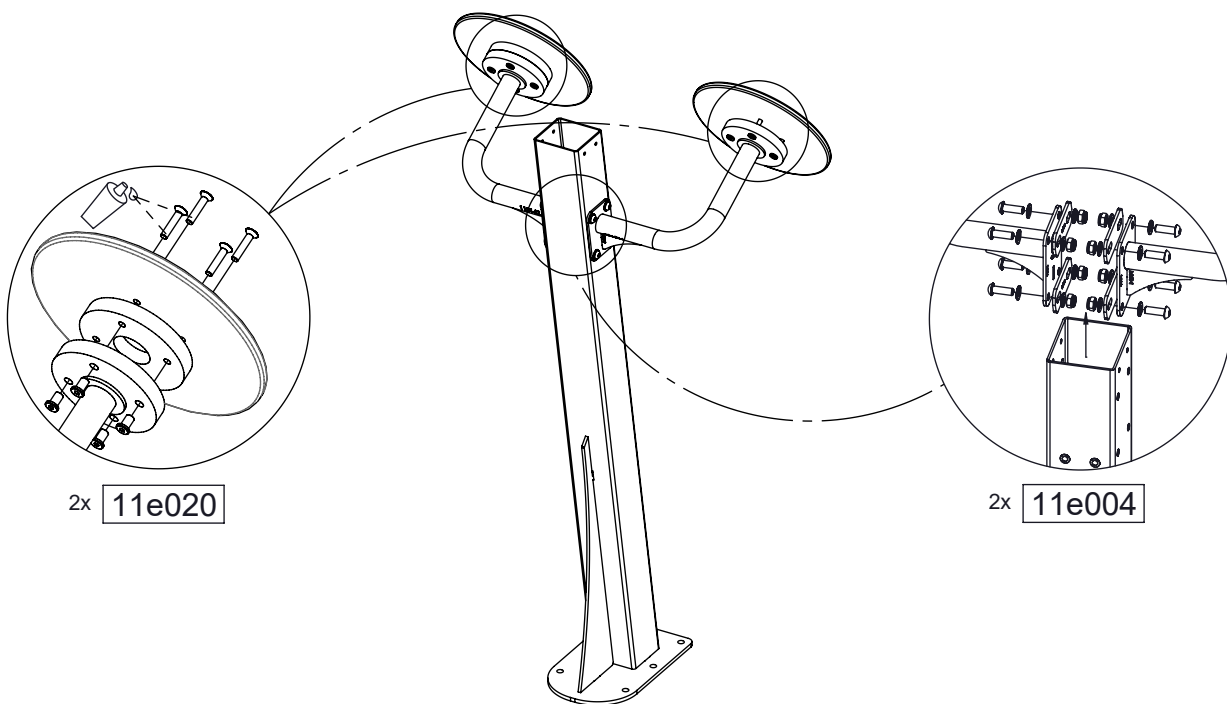

2x 11e020

2x 11e004

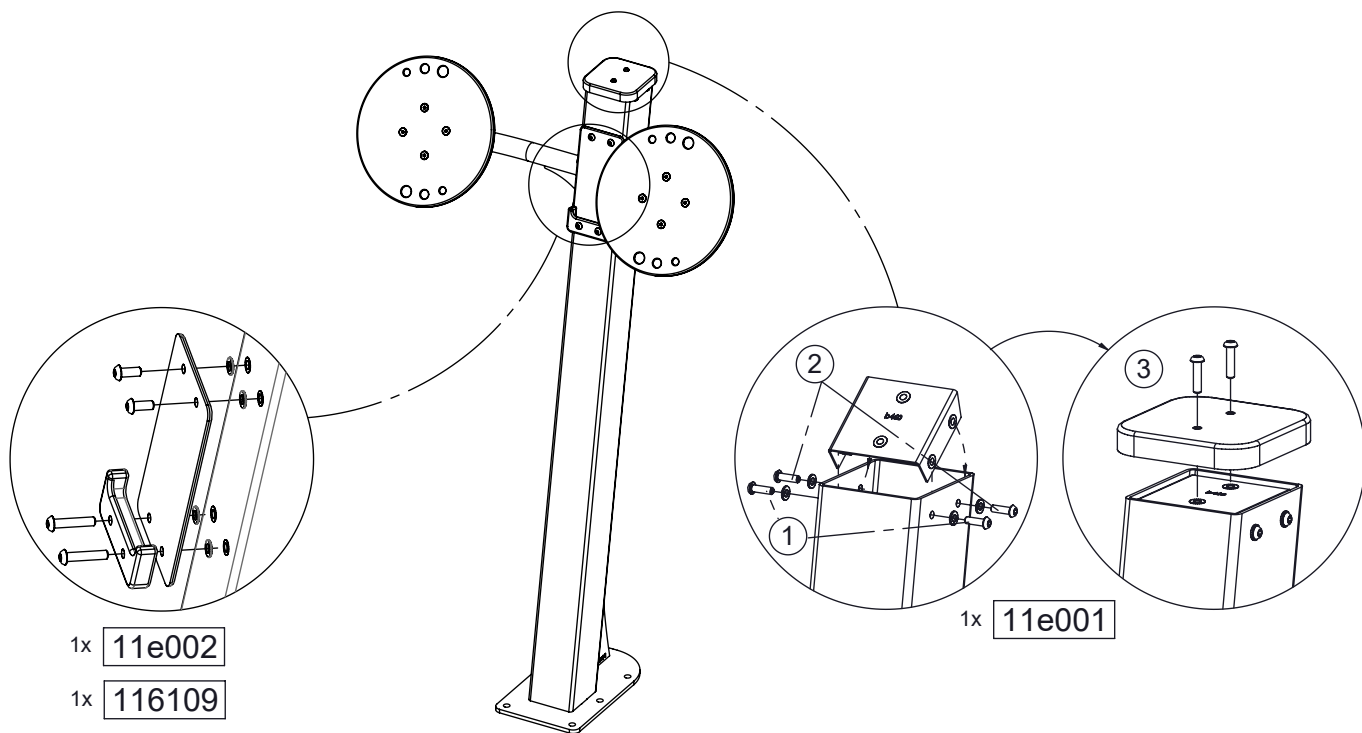

1x 11e002

1x 116109

1x 11e001

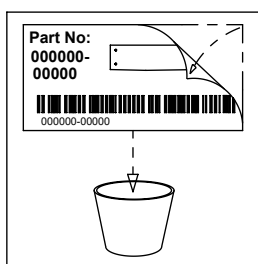

[cm]



vinci
play